

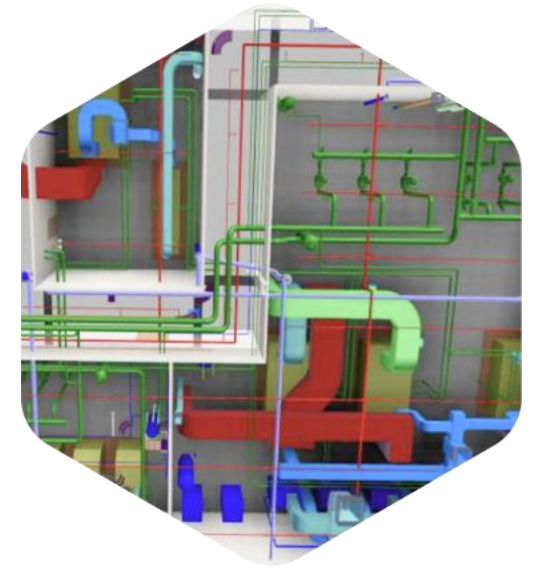

COMPANY OVERVIEW

Advenser is a multi-disciplined engineering company delivering advanced engineering services & solutions to the construction industry through innovative practices, utilizing BIM and advanced technological tools. Since 2007, we have accumulated extensive experience in the AEC industry, delivering a variety of complex projects across multiple countries with a proven track record of success.

Our engineering team, with a workforce of more than 300+ Engineers with Architectural, Structural and MEP experience, have the expertise and skillsets to meet the demands of any complex project anywhere in the world. We streamline our services to match & adapt to your constantly evolving needs.



OUR CLIENT BASE



WHAT MAKES US UNIQUE

Development, management & streamlining of integrated multi-disciplinary performance models of projects & products



Quality Standards

Multi-stage quality control methods ensure exceptional engineering quality



End to End Service

Services that span the complete project life cycle from design to maintenance



Global Operations

Sales offices & operation in multiple countries



Global Project Experience

Global track record across North America, Europe, Australasia & Middle East



Comprehensive Solutions

Comprehensive BIM / CAD Services for Architectural, Engineering, Construction & Manufacturing Industry under one roof



Trade Knowledge & Expertise

Expert resources with multinational project experience & trade knowledge



WHERE ARE WE NOW

Clients spanning across 18 countries with projects experience in over 4 continents

Multi-disciplinary engineering departments for Architecture, Mechanical, MEP, Façade, Precast, Steel & Rebar

Exceptional team of over 300+ engineers with a diverse array of perspectives, talents, business experience and technical expertise

An umbrella of diverse services and solutions for all stages of a project from design through construction to facility management

Diverse experience portfolio in residential, commercial, industrial, healthcare and educational projects

Around 10,000 projects from over 1000 clients



From humble beginnings, we have now grown to be one of most prominent global engineering services providers by setting the highest for our conduct and reputation in everything we do.

OUR SERVICES

ARCHITECTURAL BIM



BIM OBJECT LIBRARIES

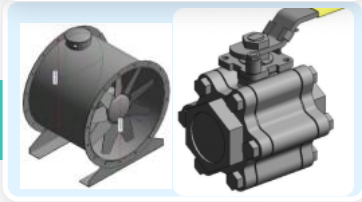

COMPREHENSIVE BIM



FAÇADE DETAILING

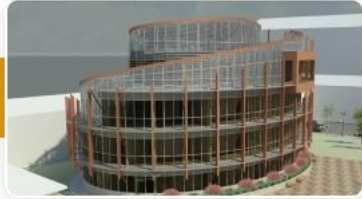

INFRASTRUCTURE BIM



INDUSTRIAL PLANT DIGITIZATION



MECHANICAL CAD/CAM



MEP COORDINATION



SCAN TO BIM



STEEL/PRECAST/REBAR DETAILING

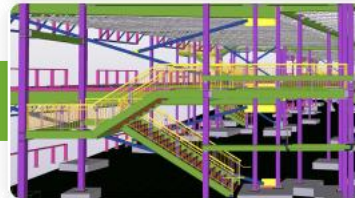

BIM TRAINING



ADVENSER IN BIM SUPPLY CHAIN

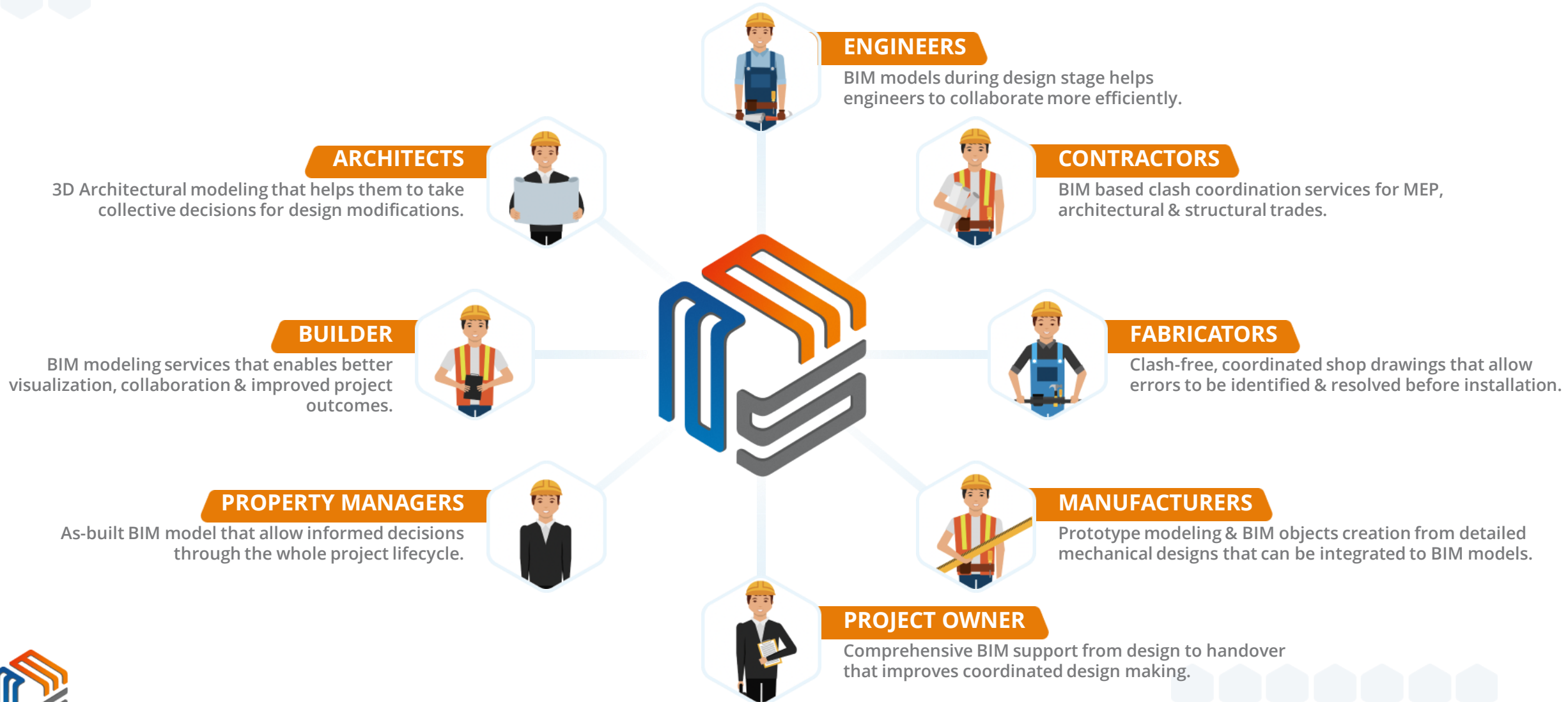

ARCHITECTURAL MODELING

Intelligent visualization of projects with broad level of details and calculations to improve the quality of delivery and turnaround the time.

ARCHITECTURAL BIM

SHOP DRAWING CREATION

DESIGN DEVELOPMENT

CONSTRUCTION DOCUMENTATION

POINT CLOUD MODELING



MEP & HVAC BIM

We place ourselves before the AEC industry as a conversant workforce of MEP/HVAC engineers providing MEP BIM services to various sectors which include educational institutions, healthcare, plants, residential, commercial and industrial buildings.

3D COORDINATION & CLASH REPORT

SHOP & FABRICATION DRAWING

DESIGN DEVELOPMENT

POINT CLOUD MODELING

SPOOL DRAWING

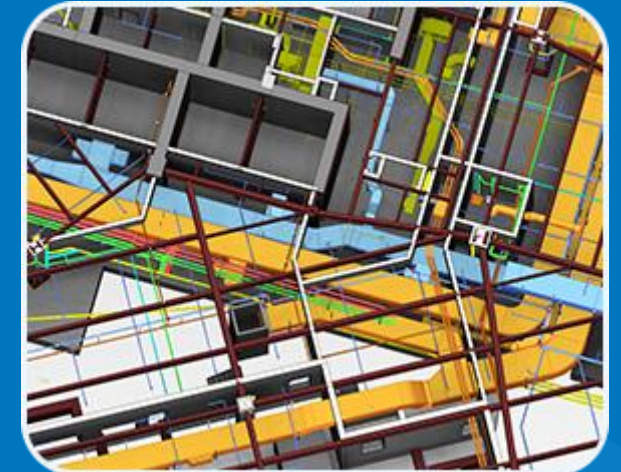
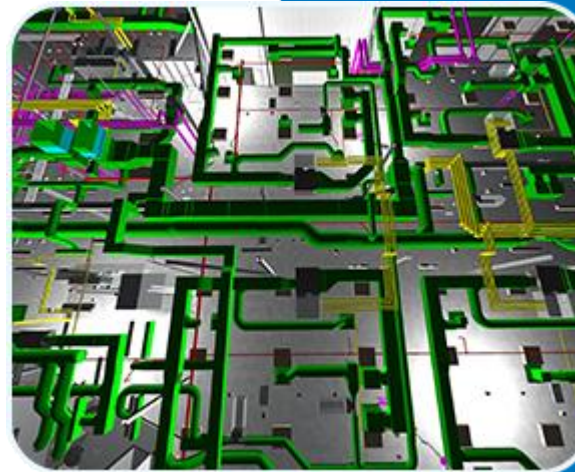
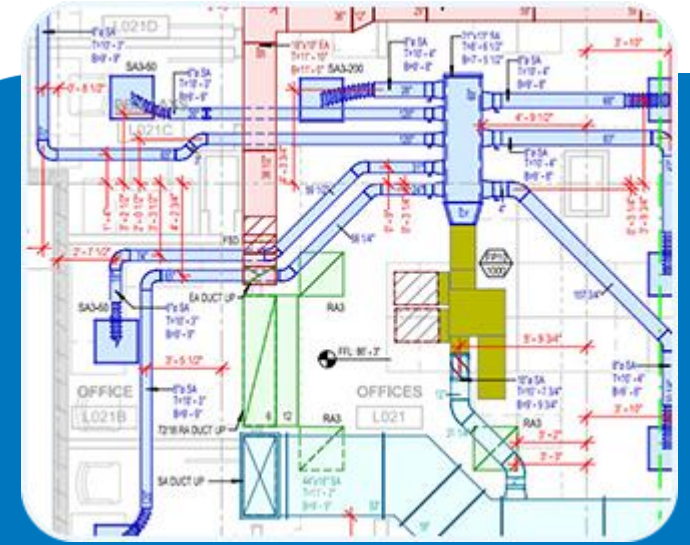
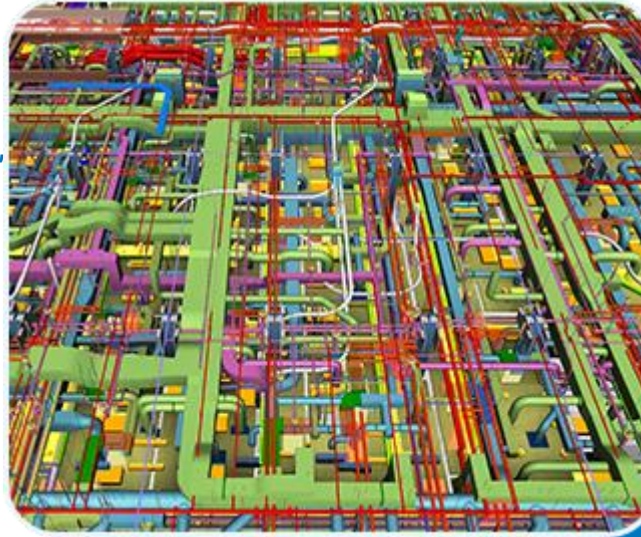

STEEL, PRECAST & REBAR DETAILING

An established lineup of effective detailing services to ensure effective management of design and project constructability for reduced cost of installation and business growth.

STRUCTURAL STEEL DETAILING

PRECAST DETAILING

REBAR DETAILING, BAR BENDING LIST

CONCRETE DETAILING

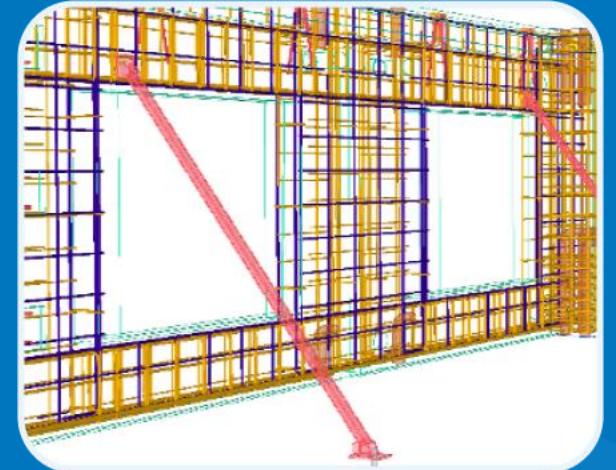
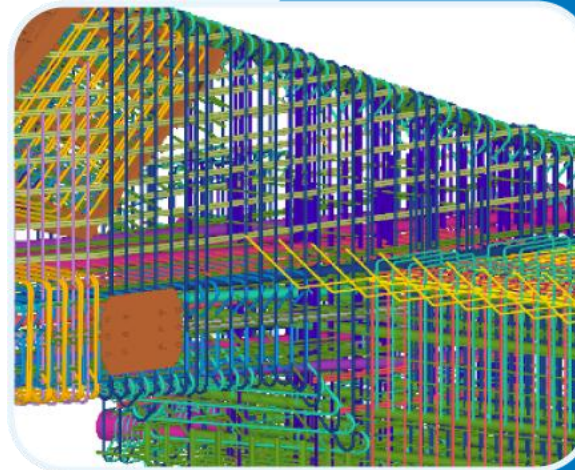
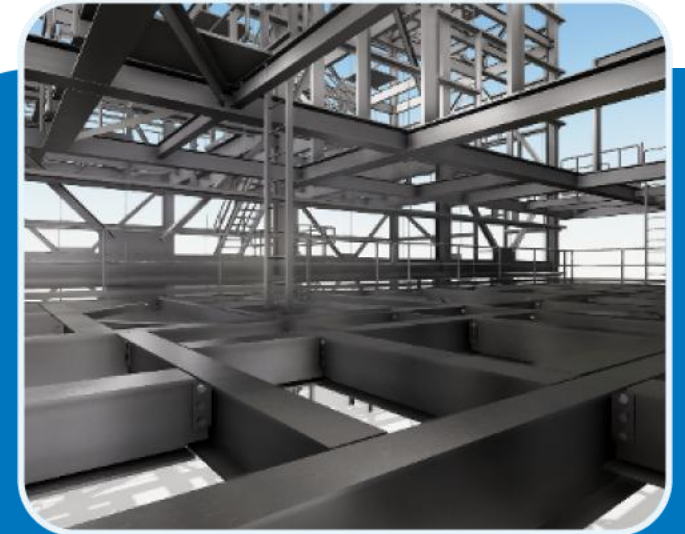
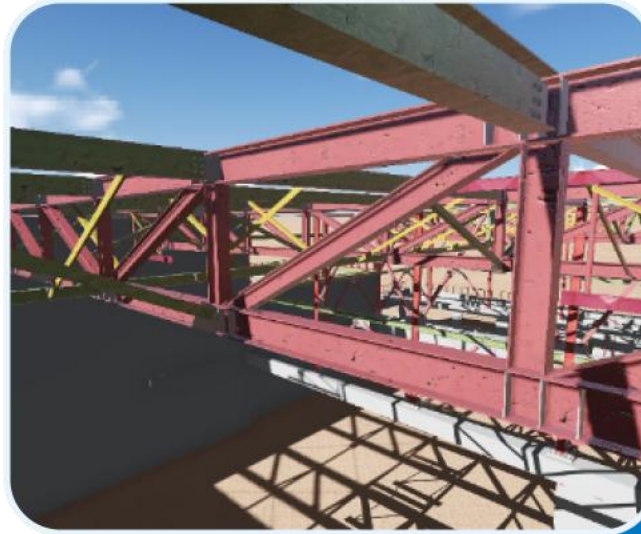

FACADE ENGINEERING SERVICES

Accurate shop & fabrication drawings enabling clients to plan for optimized & balanced production of building envelope systems

CURTAIN WALLS

SPIDER GLAZING

SHOP FRONTS & FRAMELESS GLASS

METAL PANELS & HAND RAILS

SKY LIGHTING & CANOPIES

WINDOWS, SLIDING/PARTITION DOORS

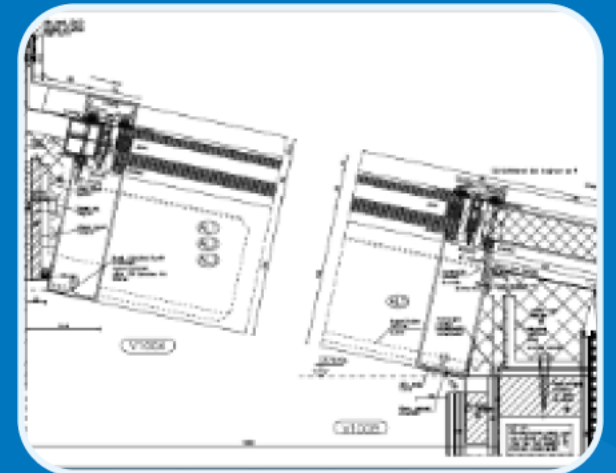
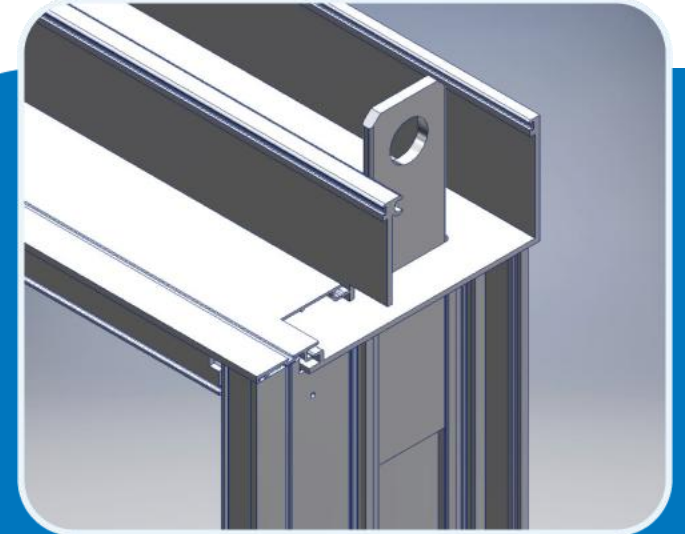
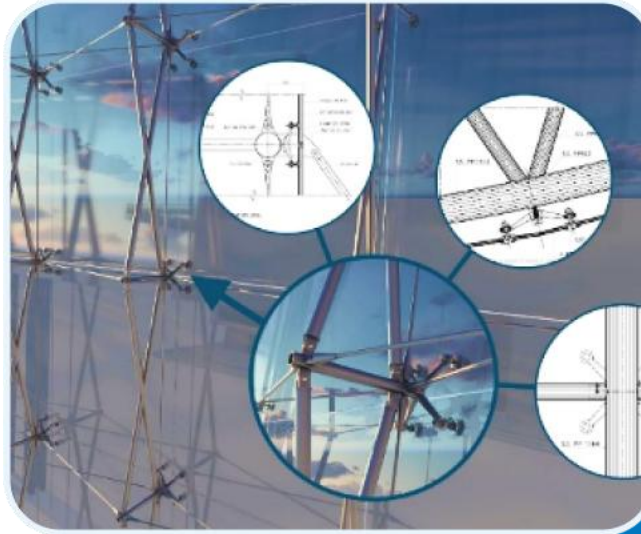

CLASH DETECTION & RESOLUTION

Seamless coordination of MEP with Architecture & Structural trades, allowing all systems to work in perfect synchronization and at the same time maintaining the design intent

ARCHITECTURAL BIM

STRUCTURAL BIM

MEP BIM

RESOLUTION OF CLASHES

ONLINE COORDINATION MEETINGS

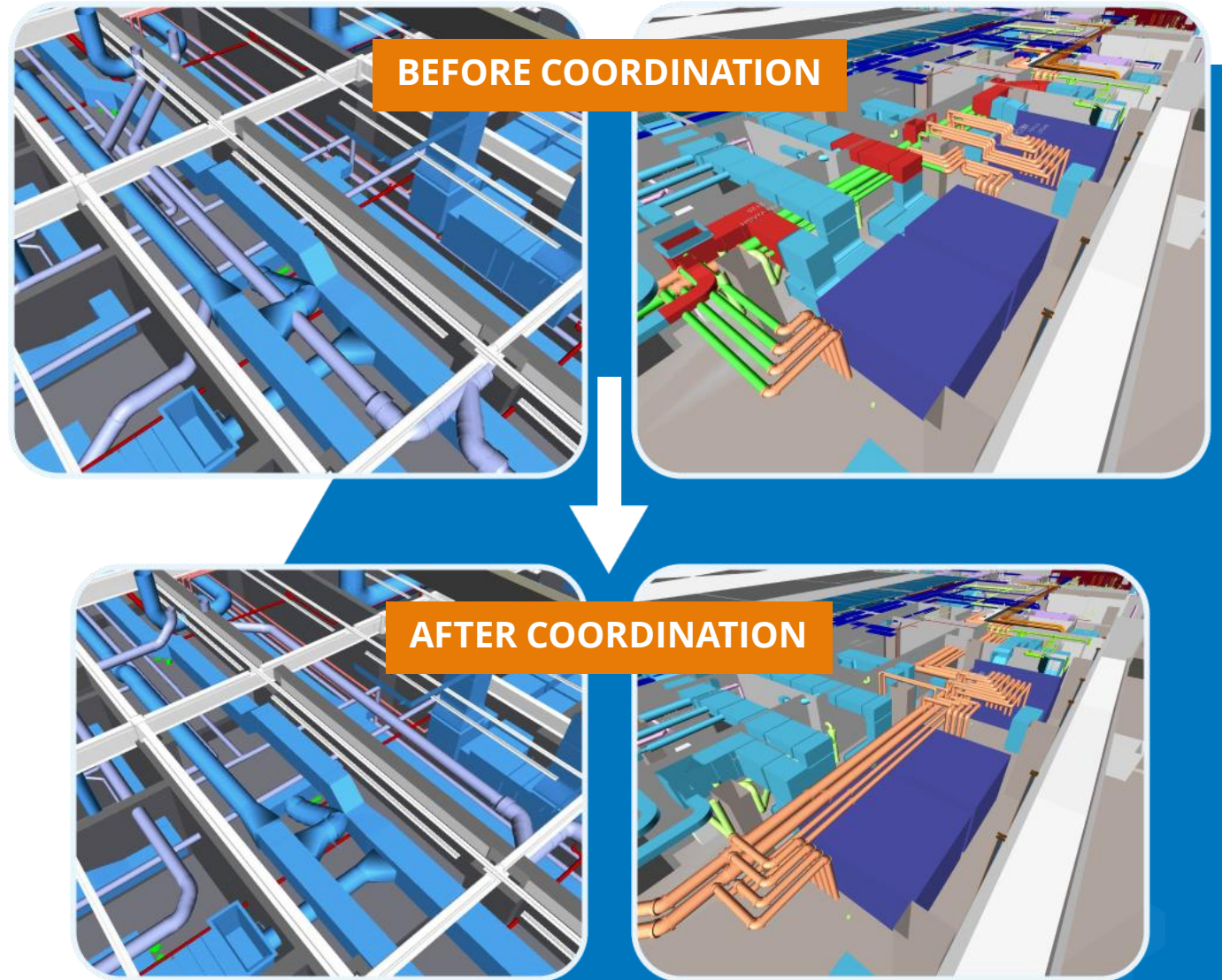

INTEGRATED BIM PROJECT DELIVERY

Helping organizations leverage the potentials of BIM integrating architectural, structural, mechanical & plumbing systems

ARCHITECTURAL BIM

STRUCTURAL 3D MODELING

HVAC & PLUMBING MODELING

BIM CLASH COORDINATION

SHOP/FABRICATION DRAWINGS

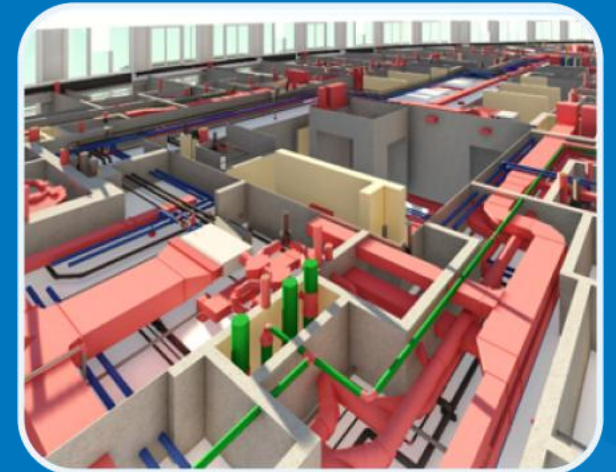
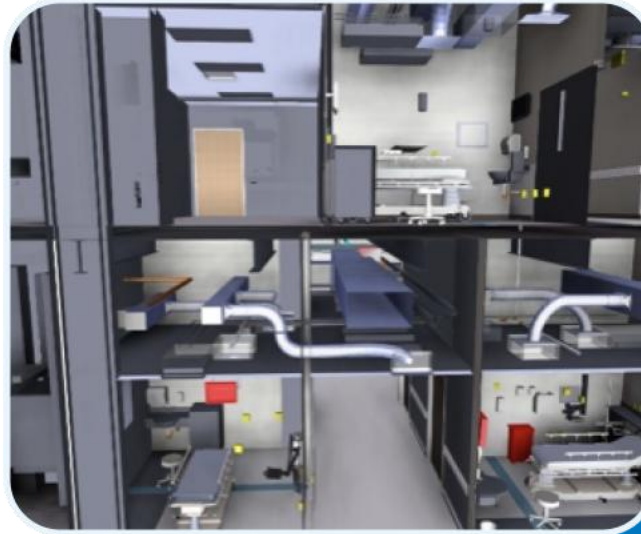

INFRASTRUCTURE BIM

Integrated approach to model multi-disciplined trades for utility structures, power stations, water treatment plants, highways & bridges

BRIDGE INFORMATION MODELING

BIM FOR WATER TREATMENT PLANTS

LANDSCAPE & SITE MODELING

TUNNEL INFORMATION MODELING

MARINE/OFFSHORE STRUCTURE MODELING

BIM FOR TRANSPORTATION

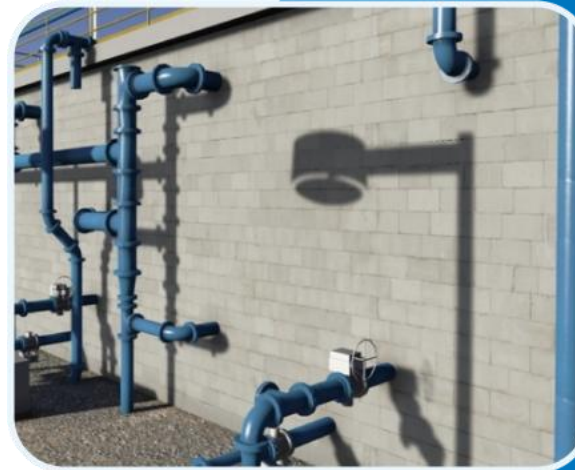
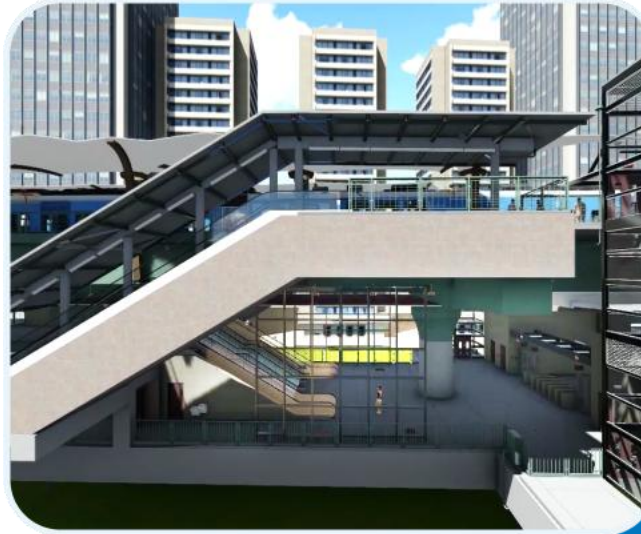

MECHANICAL CAD/CAM

Our core expertise lies in providing 2D drafting & CAD 3D modeling services to clients for the fabrication & manufacturing of mechanical components.

SHOP DRAWINGS

FABRICATION DRAWINGS

ASSEMBLY DRAWINGS

SHEET METAL DRAWINGS

ISOMETRIC DRAWING

PARAMETRIC MODELING

3D SOLID MODELING

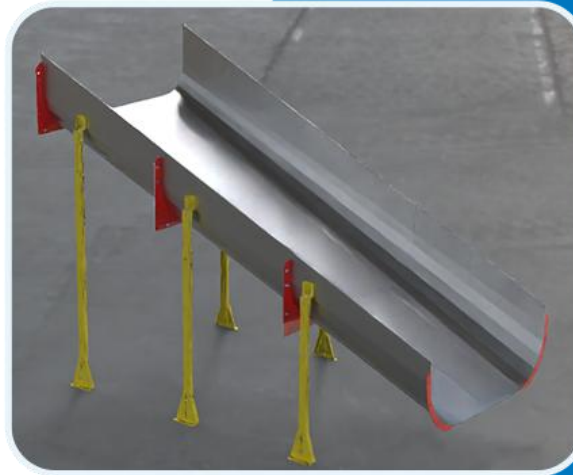
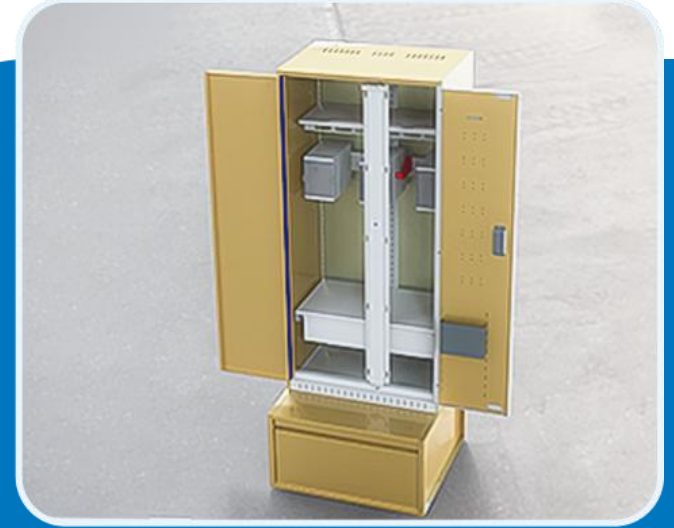

INDUSTRIAL PLANT DIGITIZATION

We create intelligent 3D models for site preparation, structural design and detailing, building design, piping and equipment layout. Enhance and integrate multidisciplinary collaboration and minimize data loss across your project.

LiDAR SCANNING

REVERSE ENGINEERING

SCAN TO DWG

AS-BUILT DOCUMENTATION

3D MODELING

LEGENDARY DRAWING

P & ID, GA & EQUIPMENT DRAWING

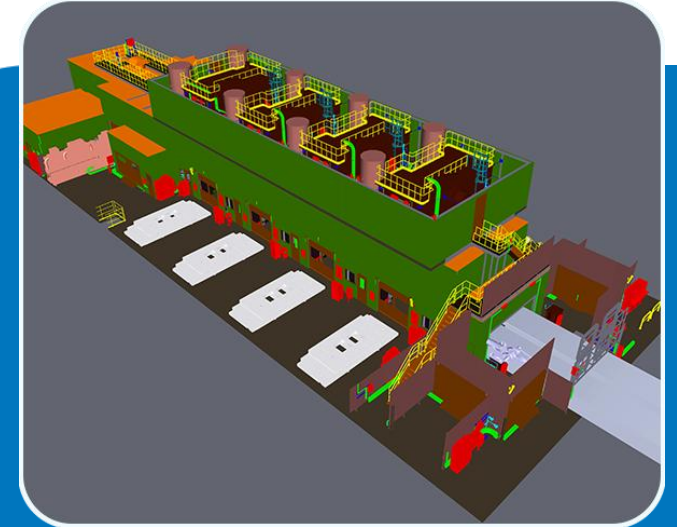

POINTCLOUD SCAN TO BIM MODELING

The 3D BIM model that we create from laser scan data serve as accurate models for as-built purposes as well as for retrofit, refurbishment and renovation projects.

ARCHITECTURAL CONVERSION

STRUCTURAL CONVERSION

MEP CONVERSION

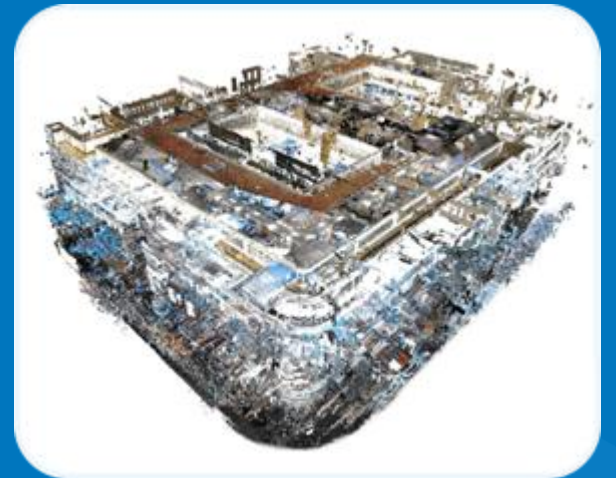

REVIT FAMILY CREATION

Creation of standard and customized revit families for the retail, manufacturing and the construction industry from the manufacturer's submittals or even hand sketches.

ARCHITECTURAL ELEMENTS

STRUCTURAL COMPONENTS

MECHANICAL FITTINGS

PLUMBING FIXTURES

PRODUCT LIBRARIES

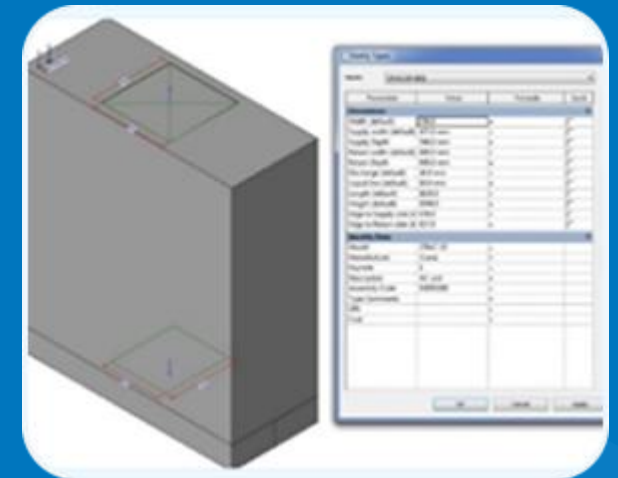
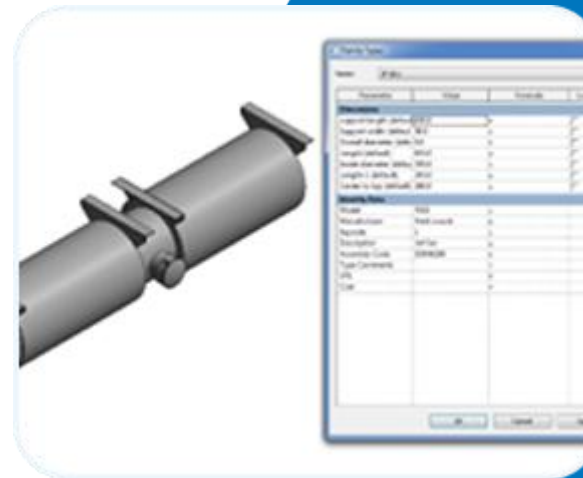
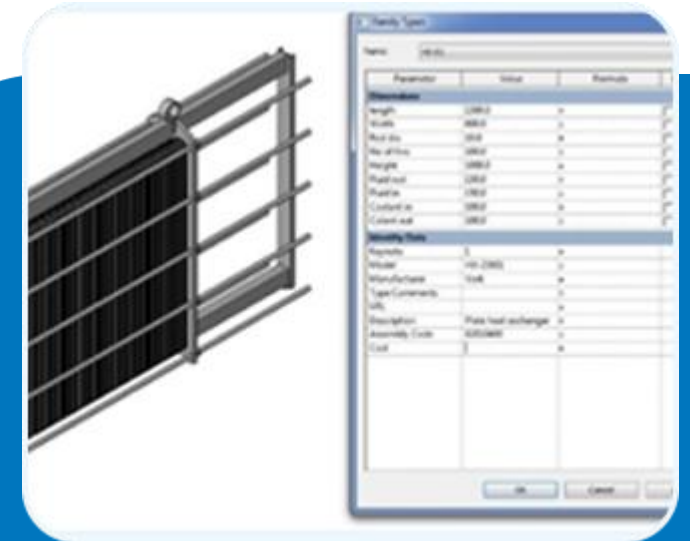
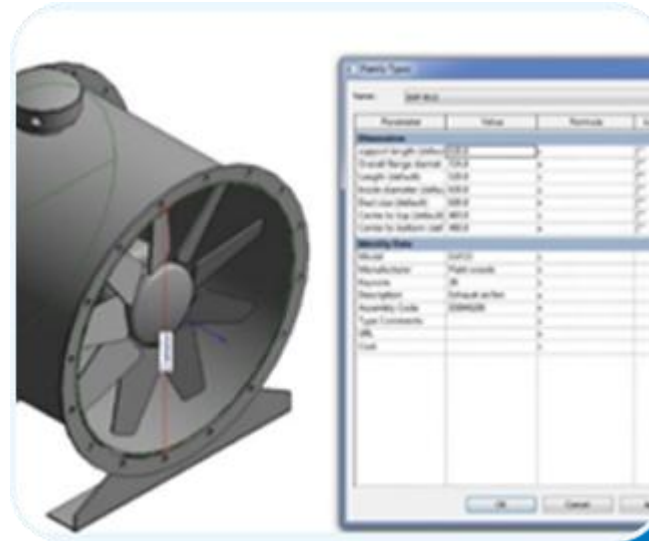

BIM CONSULTING SERVICES

Since 2007, we have been assisting construction companies, general & specialty contractors in their migration to BIM from CAD. We act as a strategic BIM partner to the client educating and training them for seamless migration from CAD drafting to BIM implementation.

BIM MODEL AUDIT

OFFSHORE BIM TEAM

BIM IMPLEMENTATION PLANNING





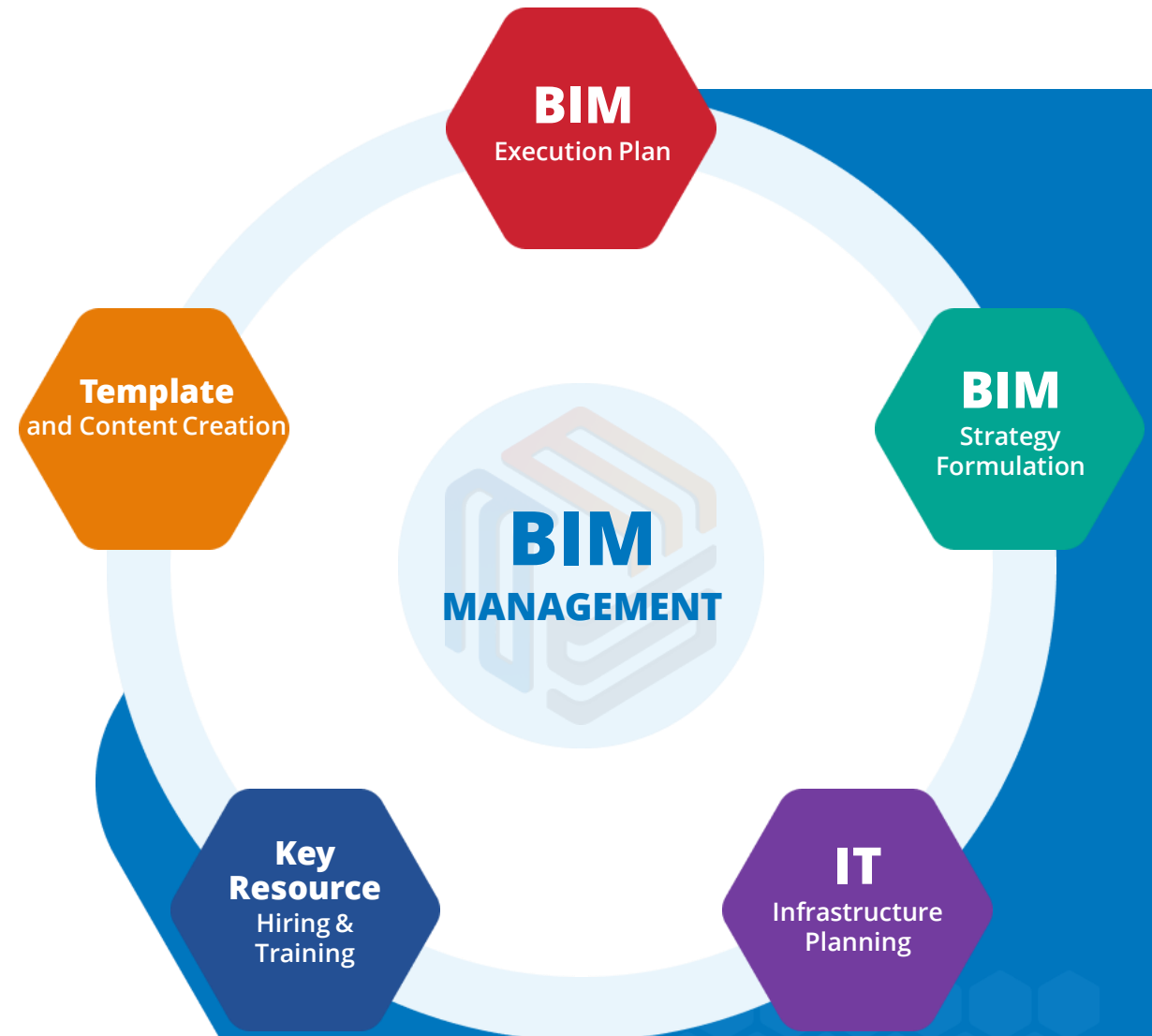



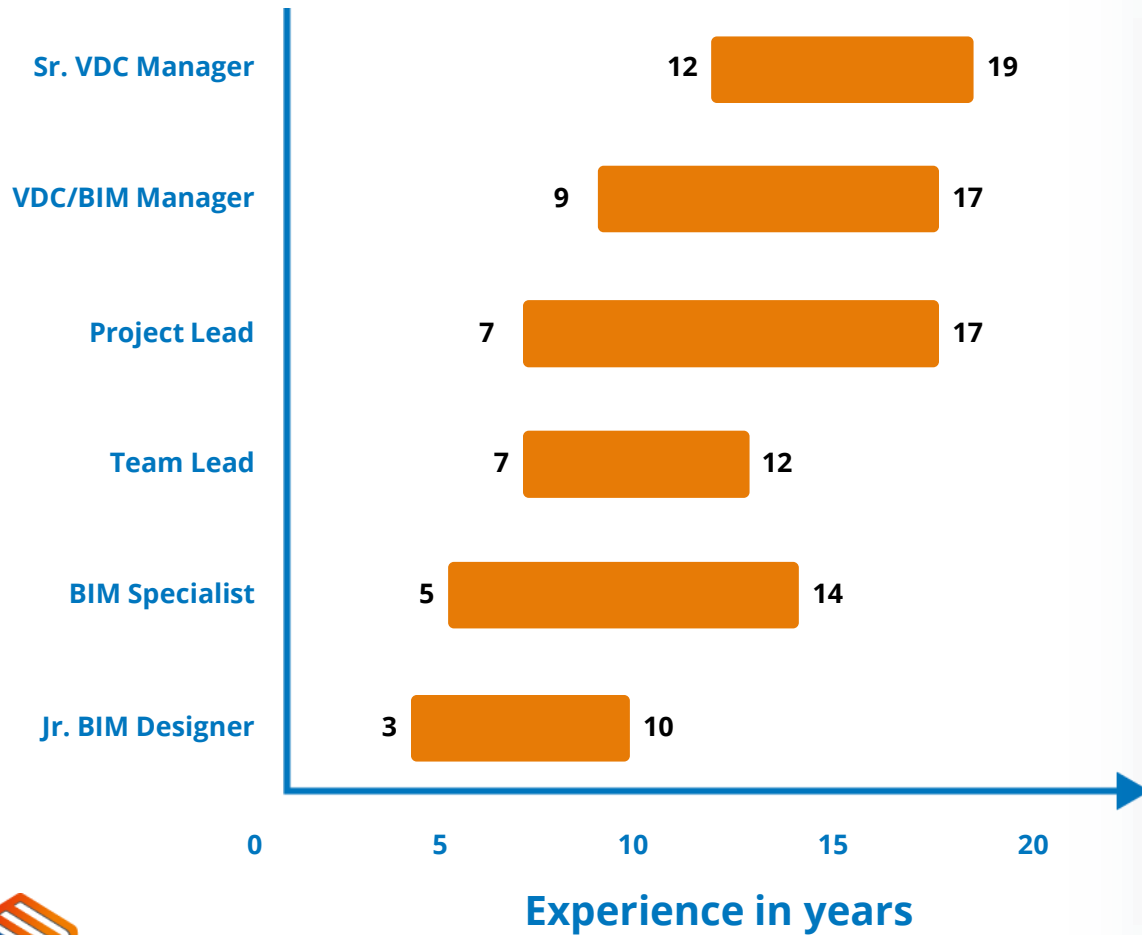





BIM TRAINING

ON-SITE BIM SUPPORT



TEAM PROFICIENCY AND SOFTWARE PROFICIENCY



 Civil 3D	 FormIt Pro	 Construction Cloud
 InfraWorks	 Insight	 MagiCAD
 Revit	 3ds Max	 LogiKal
 ReCap Pro	 Inventor	 Tekla
 AutoCAD MEP	 Fabrication CADmep	 STAAD.Pro
 Autodesk Docs	 Advance Steel	 Solid Edge
 Navisworks Manage	 AutoCAD Plant 3D	 RebarCAD
 Dynamo	 BIM Collaborate Pro	 RGS REBAR
 Trimble EC CAD, Field Technology	 Building Data	 Rhinoceros
 CloudWorx	 Synchro	

BIM TRAINING & CERTIFICATE PROGRAM

A Certificate Program in Building Information Modeling (BIM) is available at East Stroudsburg University (ESU) through a partnership between ESU and Advenser Technology Services, Inc. (Advenser).



EXPLORE
OUR
COURSES



BIM for
Beginners



BIM Proficiency
Training



BIM for Building Utility
Services



BIM Manager
Training

BIM for Structural
Engineering

BIM for Facade
Engineering

BIM for Steel
Detailing

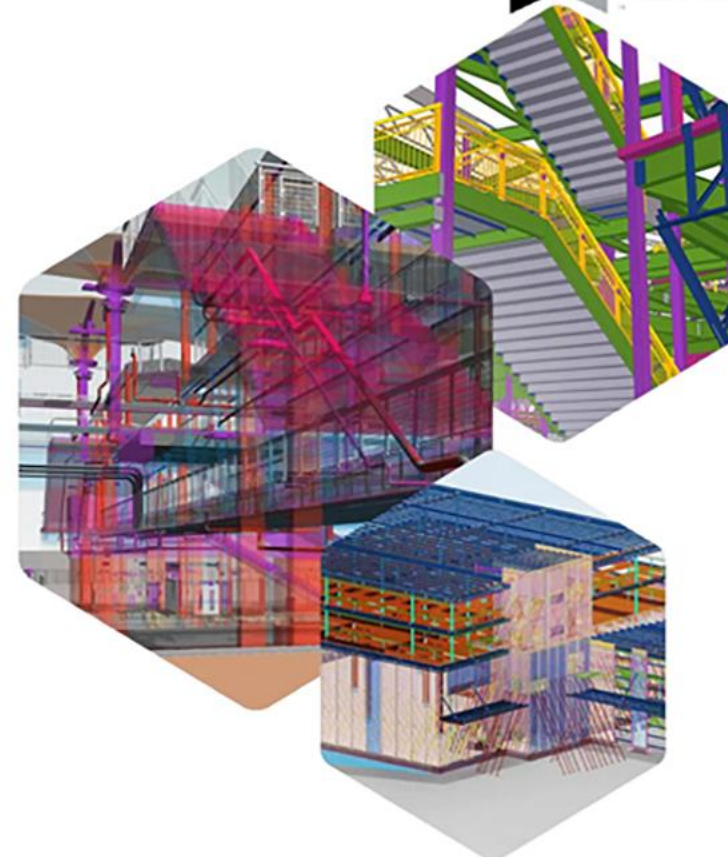

Accredited by



CONTACT US



Advenser Technology Services, Inc.

Five Neshaminy Interplex, STE 205
Trevose, PA 19053, USA
Phone: +1 (215) 791 7955



Advenser LLC

Five Neshaminy Interplex, STE 205
Trevose, PA 19053, USA
Phone: +1 (215) 934 2868



Advenser Engineering Services Pty. Ltd.

Unit 26, 14 Jubilee Avenue
Warriewood NSW 2102, Australia
Phone: +61 363 877 090



Advenser Engineering Services Pvt. Ltd.

43 A, E block, 4F CSEZ, Kakkanad
Kochi, Kerala, India. Pin 682 037
Phone: +91 484 298 8448



Advenser Engineering Services Pvt. Ltd.

403, 4F, Lulu Cyber Tower 1, Infopark Kochi,
Kerala, India. Pin 682 042
Phone: +91 484 404 0708



Advenser Engineering Services Pvt. Ltd.

Commerce Mantri, No. 12/2, 7F, BTM 2nd Stage,
Bangalore, Karnataka, India. Pin 560 076
Phone: +91 998 059 4353



Advenser Engineering Systems LLC

P.O. Box No: 118901,
Dubai, UAE
Phone: +971 50 237 7430



www.advenser.com



info@advenser.com

THANK YOU

